

# Optical Fiber sensing technologies

Kurosh Bozorgebrahimi  
Senior Advisor, Optical Network



# Outline

- Optical Fiber Sensing technologies

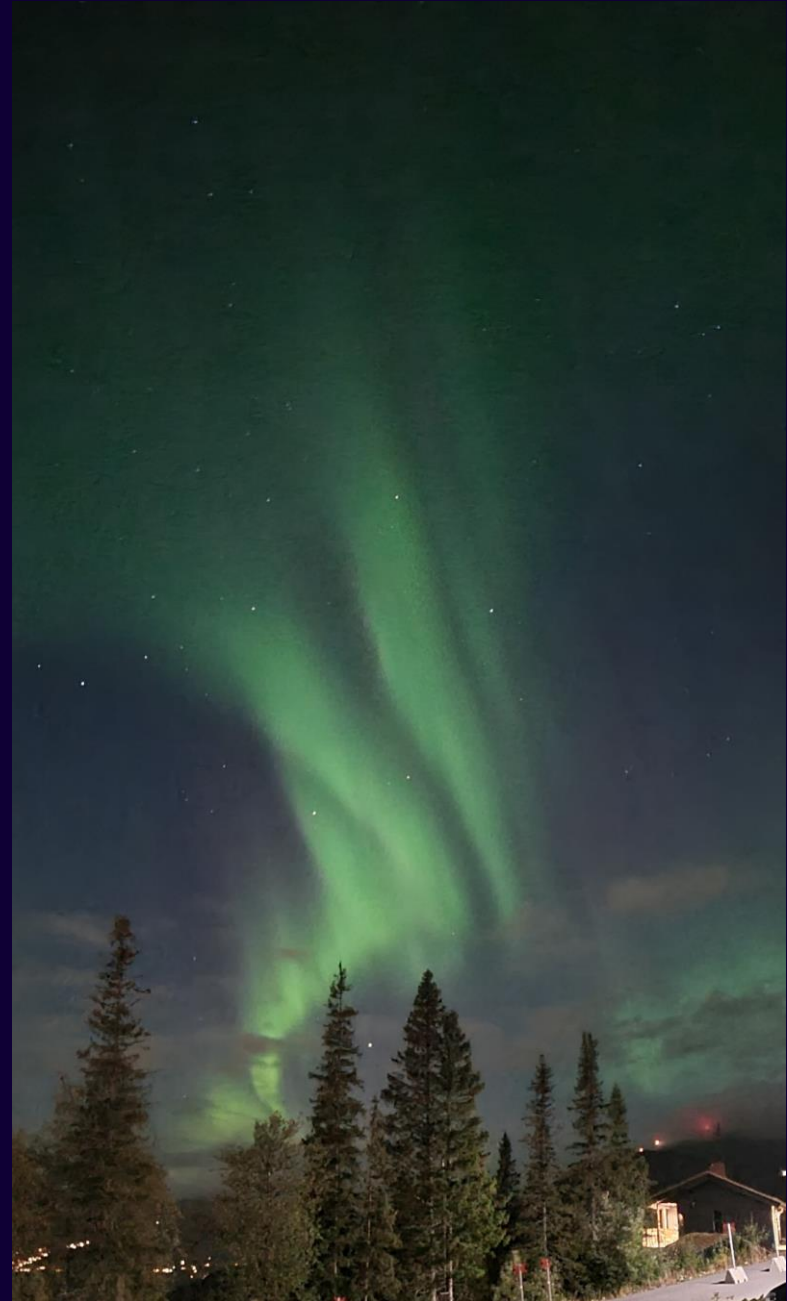

# Optical Fiber sensing

- Point based sensing: discrete sensors measuring at pre-determined points
  - A widely used device for that is “Fiber Bragg Grating”
- Distributed sensing utilizes the optical fiber to enable simultaneous measurements at multiple locations along the fiber
  - Commonly based on Scattering properties of the light
  - State Of Polarization
  - Phase Interferometry

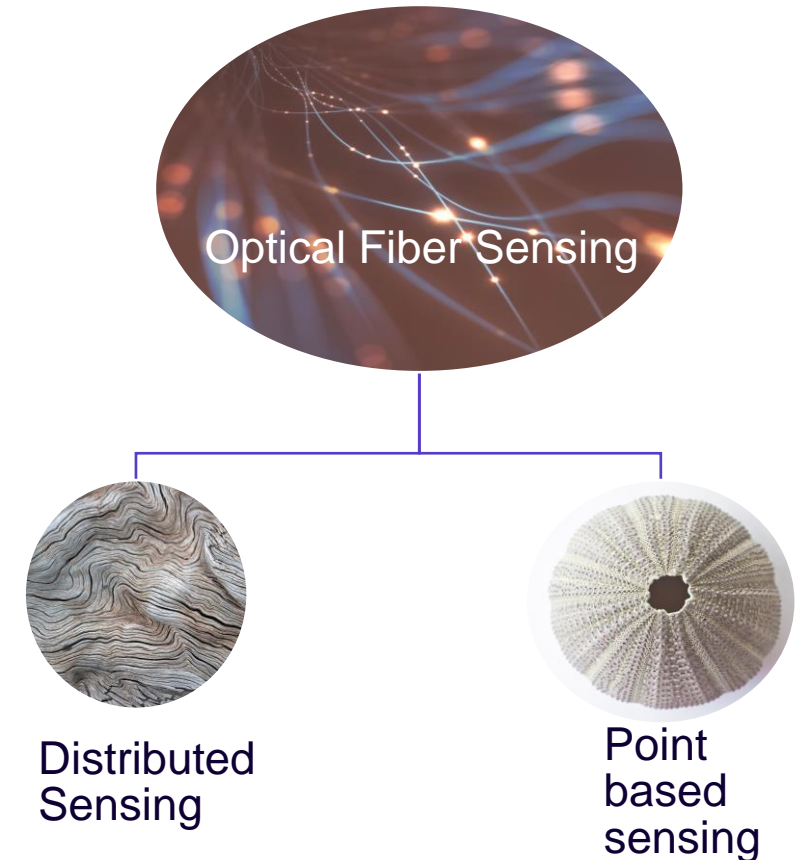

# Fiber Bragg Grating

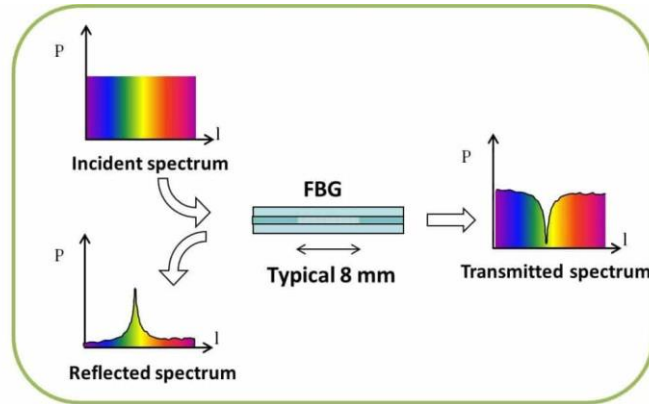

- FBG is one of the components which is widely used at Point based sensing
- A FBG is a kind of fiber grating based reflector which reflect a particular wavelength depends on grating period

$$\lambda_B = 2 n_e \Lambda$$

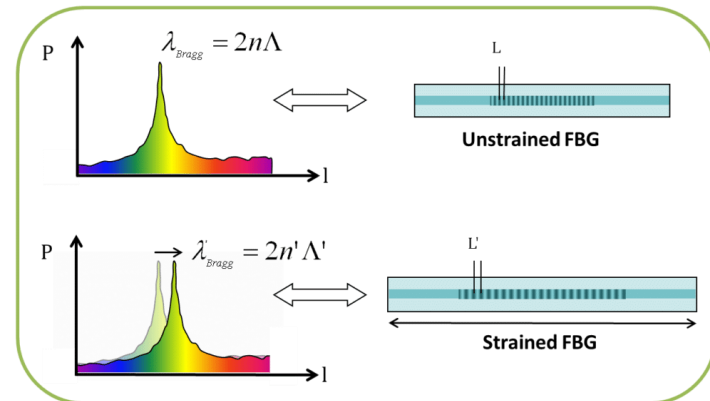

Images: <https://fbgs.com/technology/fbg-principle/>

- First have been demonstrated in 1978.
- In 1989, The technique uses the interference pattern of ultraviolet laser light to create grating pattern.

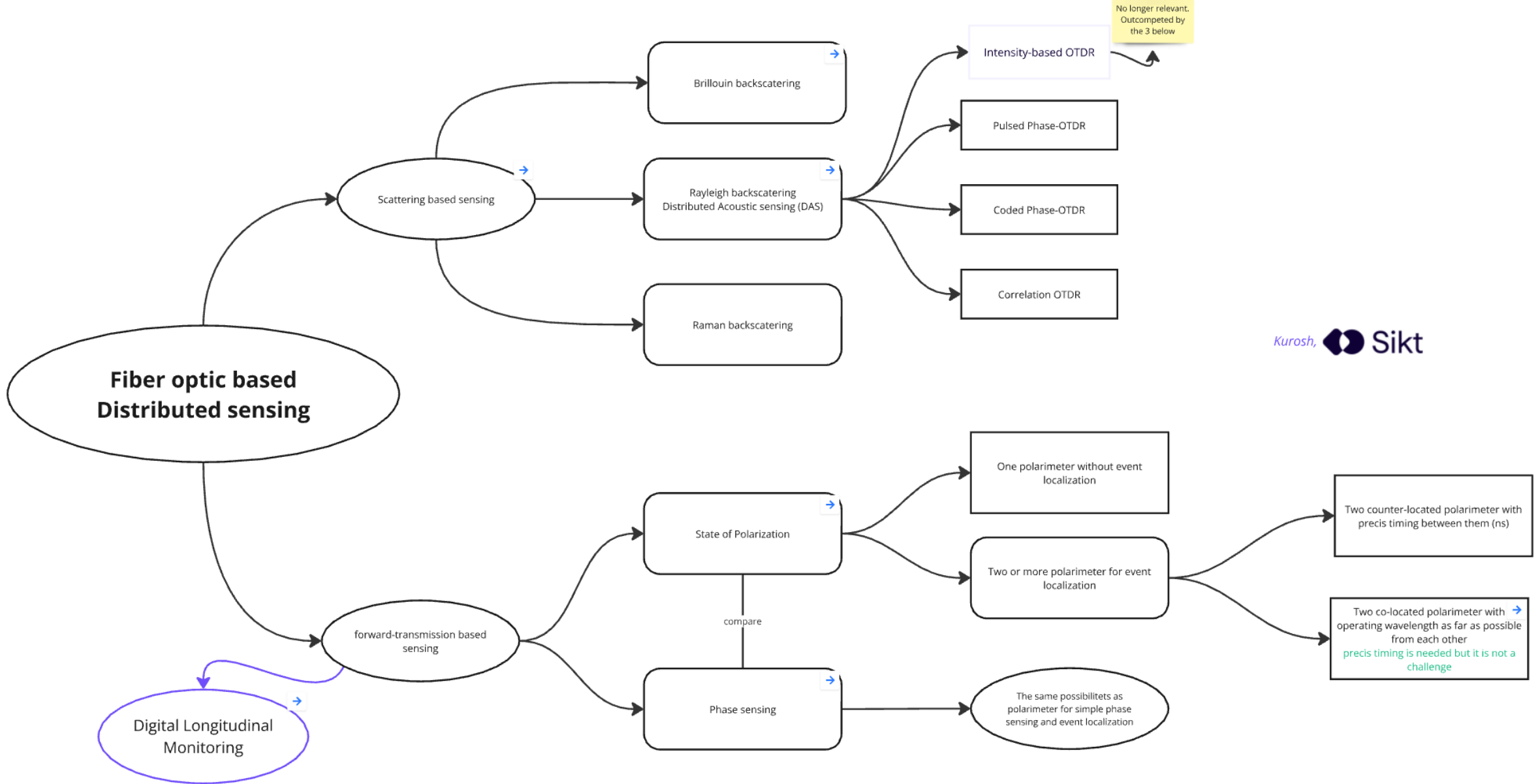

## What is the State Of Polarization

- Light beam is composed of two **orthogonal electrical vector field** components. Polarized light occurs when these two components differ in **phase or amplitude**.
- Different polarized optical waves propagate with different propagation constants which is related to intrinsic fiber **birefringence**
- The **intrinsic fiber birefringence** arises from the imperfect fiber manufacturing, such as **core ellipticity**, bending, twisting, or even material impurities and inhomogeneities
- Both **internal and external factors** can influence the fiber birefringence
  - Internal issues relate mostly to imperfections of the fabrication process
  - **external factors: changes in environmental conditions (rain, wind gust, snow, heat, or temperature variations), mechanical stress and pressures**
- Measured SOP in a give point is a result of stochastic changes of polarization along the fiber path

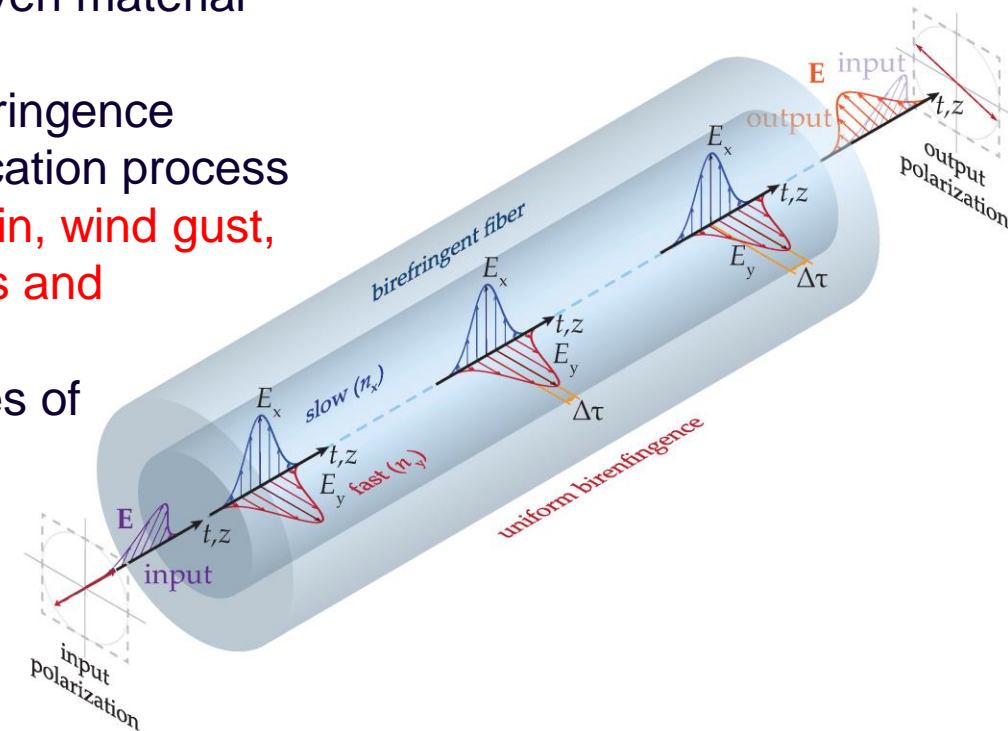

## The State Of Polarization for event detection

- The Stokes parameters are a set of values that describe the polarization state
- Stokes parameters are used in polarimeter to monitor the state of Polarization
- In 1852, Sir George Gabriel Stokes (1819 - 1903, mathematician, physicist, politician and theologian of Ireland), found that any **state of polarized light could be completely described by four measurable quantities**
  - The total intensity of the light (polarized + unpolarized)  $S_0$
  - The intensity of linear horizontal or vertical polarization  $S_1$
  - The intensity of linear  $+45^\circ$  or  $-45^\circ$  polarization  $S_2$
  - The intensity of right or left circular polarization  $S_3$

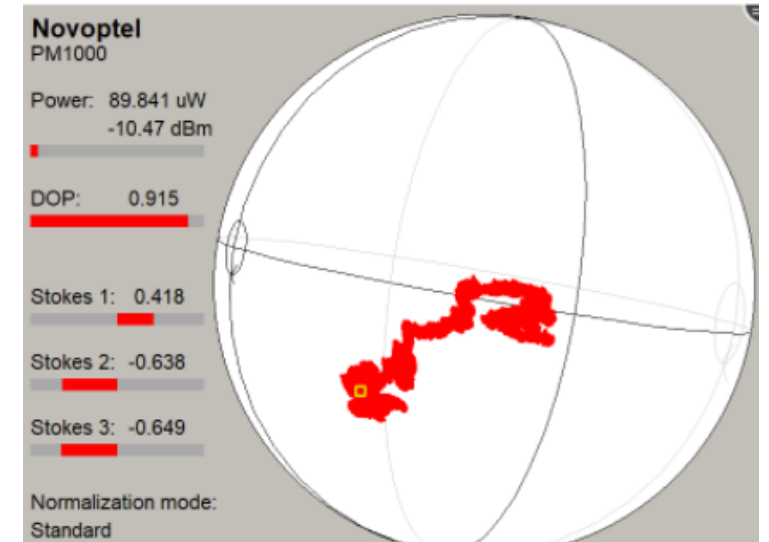

Poincare Spheres

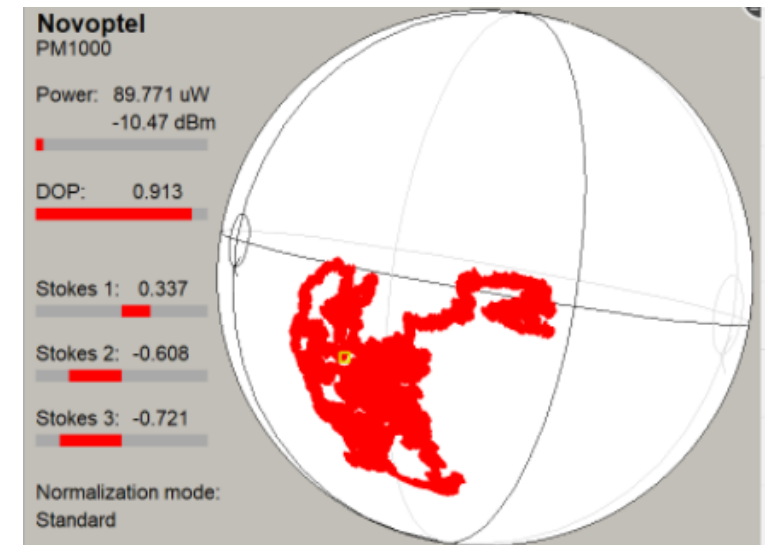



# Novoptel PM1000

Power: 0.114 mW  
-9.43 dBm

DOP: 0.907

Stokes 1: 0.613

Stokes 2: -0.588

Stokes 3: 0.529

Normalization mode:  
Standard

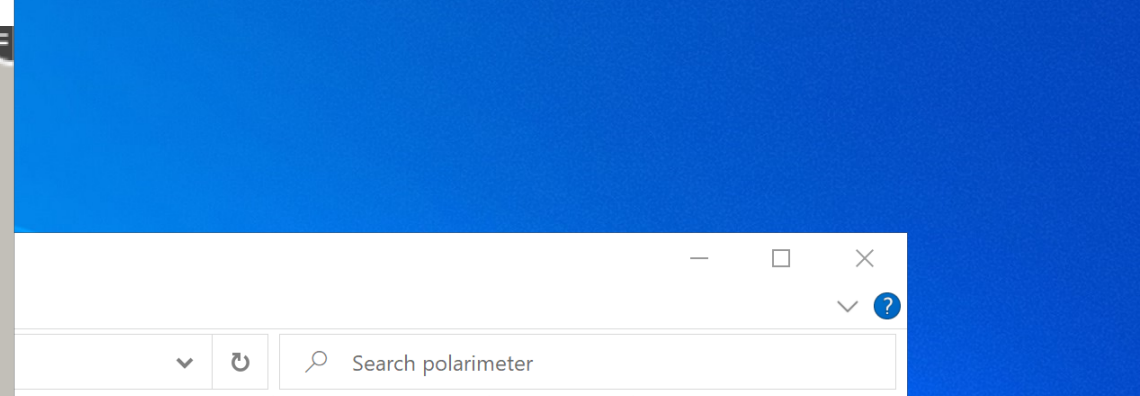
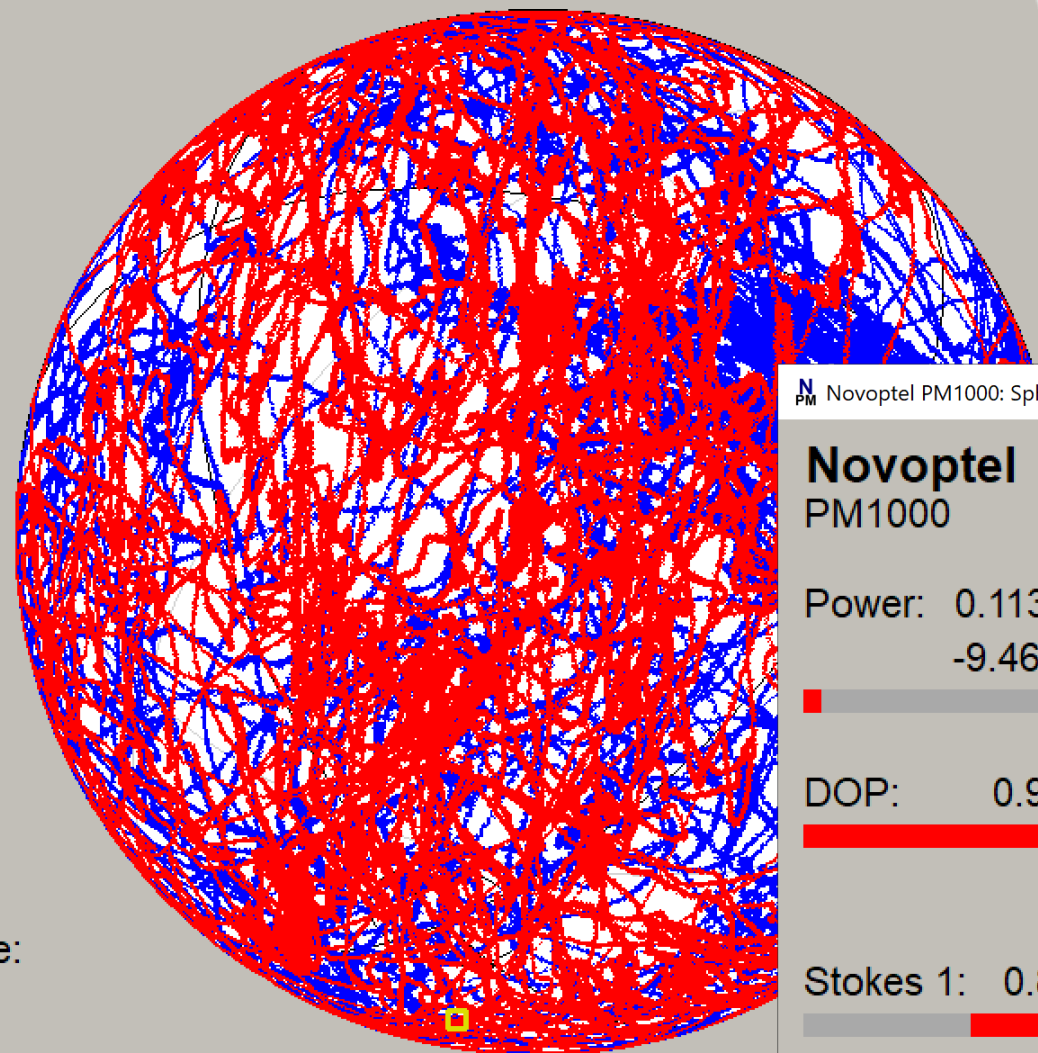

PM Novoptel PM1000: Sphere

# Novoptel PM1000

Power: 0.113 mW  
-9.46 dBm

DOP: 0.907

Stokes 1: 0.865

Stokes 2: 0.457

Stokes 3: 0.209

Normalization mode:

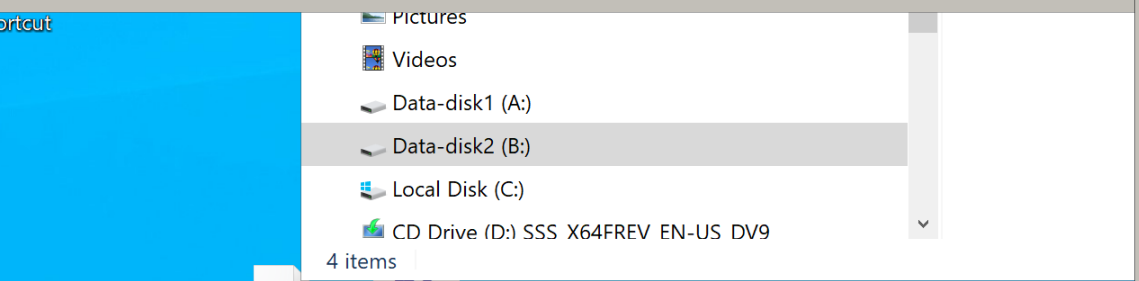
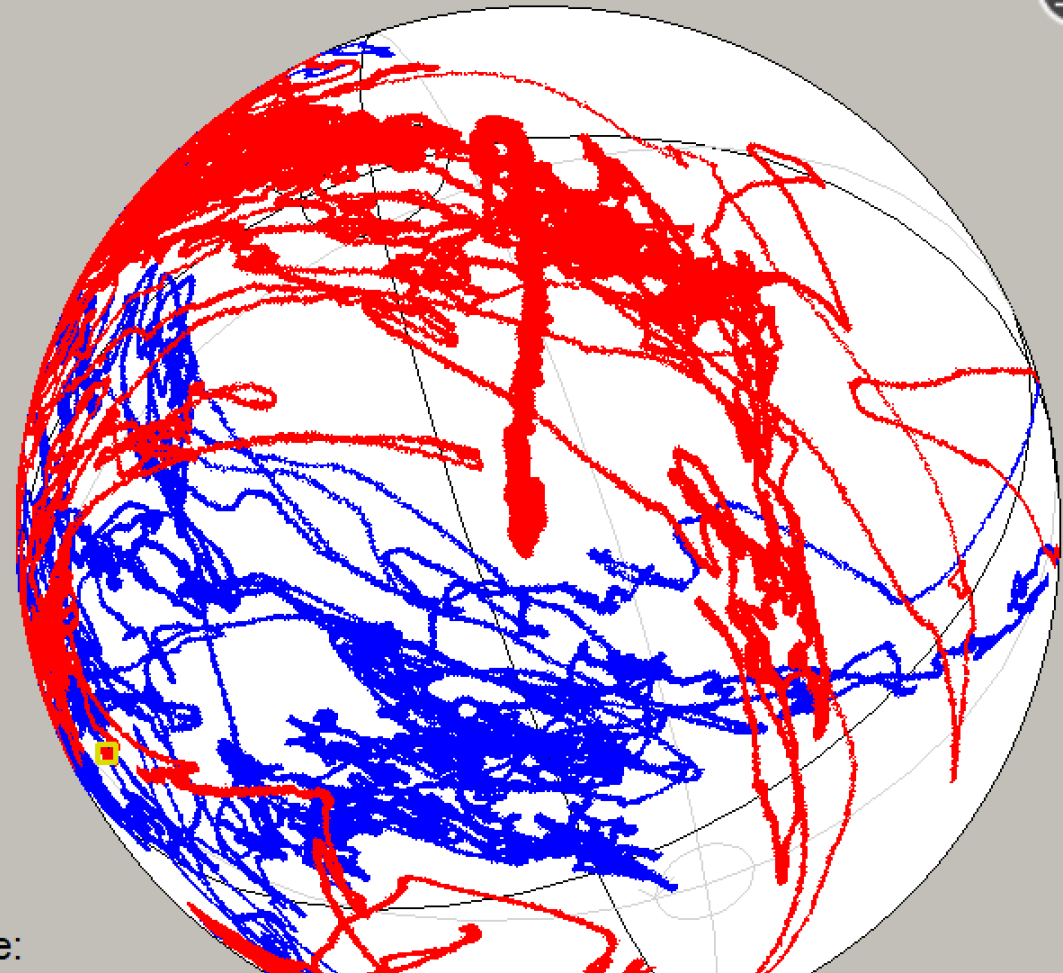



## Detection, Localization, Identification

- Sensing based SOP can detect a major event along the fiber path, but it can't localize the event.
  - For localization of event, we need additional device and calculation

## The State Of Polarization for event detection and localization (Based on CD delay method)

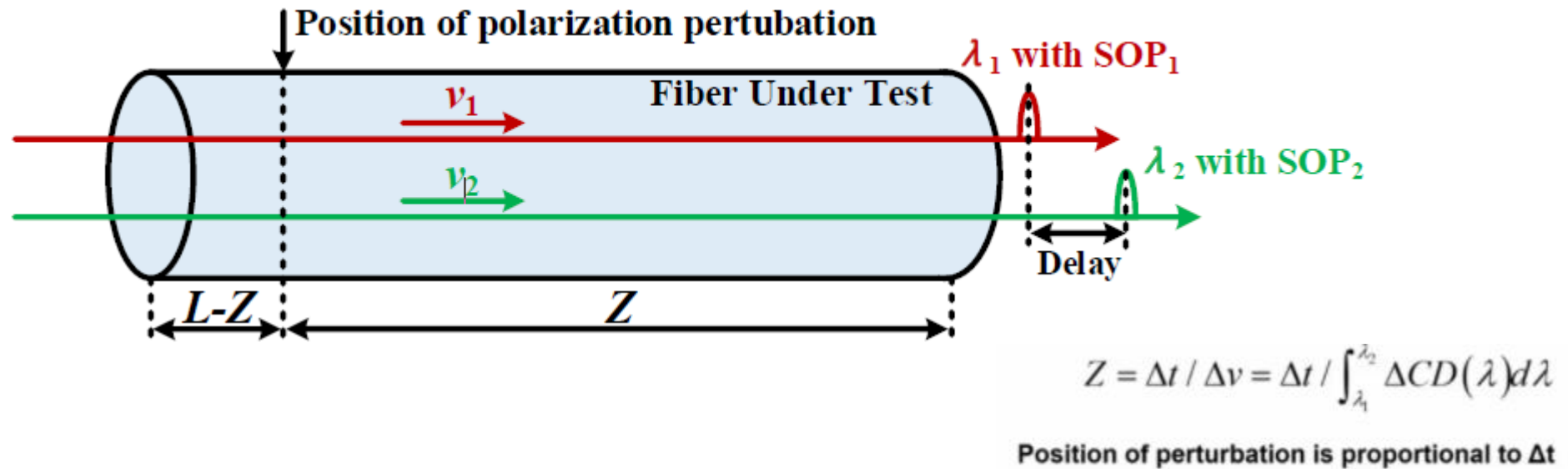

- Using two polarimeters from the same location
- Using two different wavelengths with as far as separation between them as possible (e.g. using wavelengths in the C- and L-band)
- Frequency dependence of light speed is the key parameter for event localization in this method

# The State Of Polarization for event detection and localization (Based on time delay measurement)

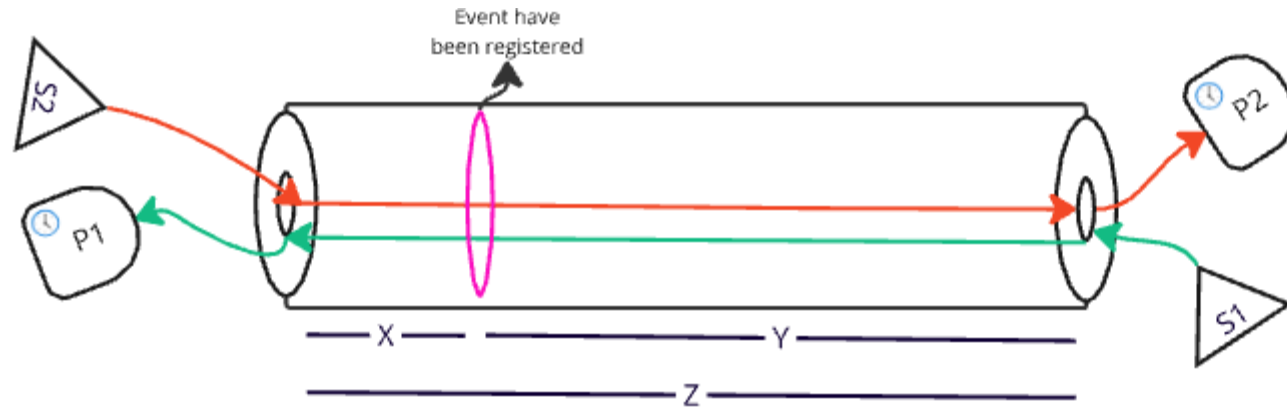

$\Delta\tau$ , Time delay between received events at the end points = Calculated by SOPs  
 $v$ , Light speed in fiber=204 357 504 m/s  
 $Z$ , Cable length =is known

$$\frac{X}{v} = \frac{Y}{v} - \Delta\tau$$

$$Y = \frac{Z + \Delta\tau \cdot v}{2}$$

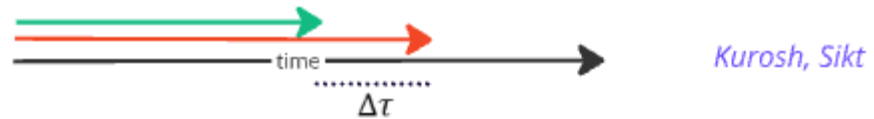

*Kurosh, Sikt*

- Using two polarimeters with same wavelength, one in each end
- Time delay between detected events on polarimeters is used to localize the event in this method

# Field test 2024: Event detection and localization by SOP the concept and test layout

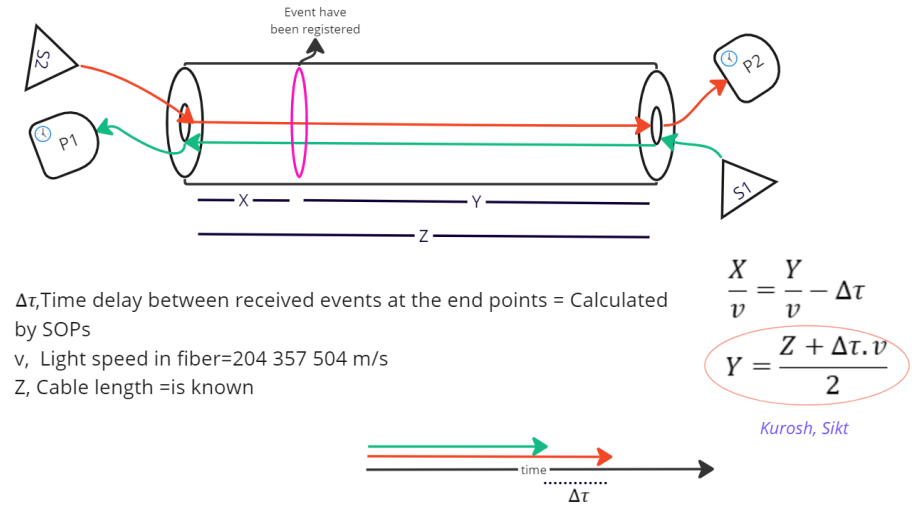
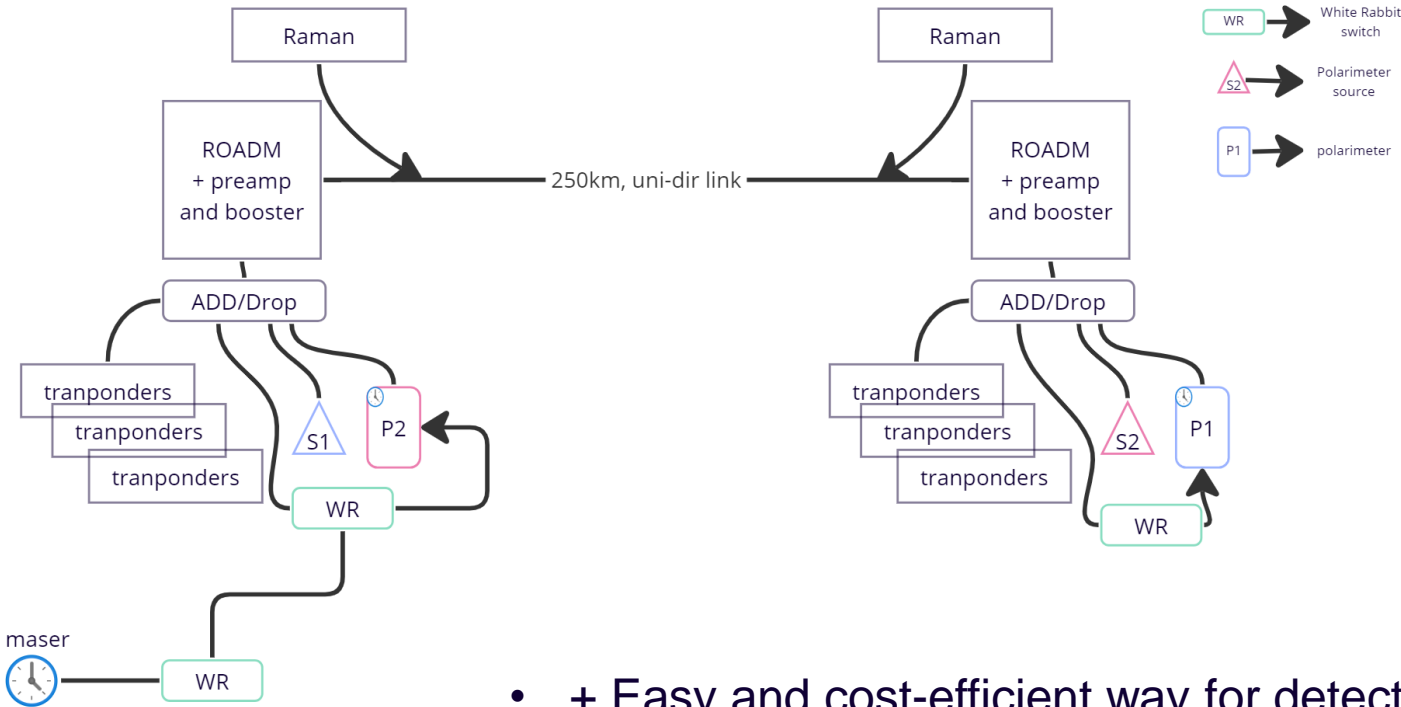

- + Easy and cost-efficient way for detection and localization of event (2 polarimeter with high level of time synchronization)
- Event identification is limited
- - multiple simultaneous events can't be detected separately

# Cross-correlation

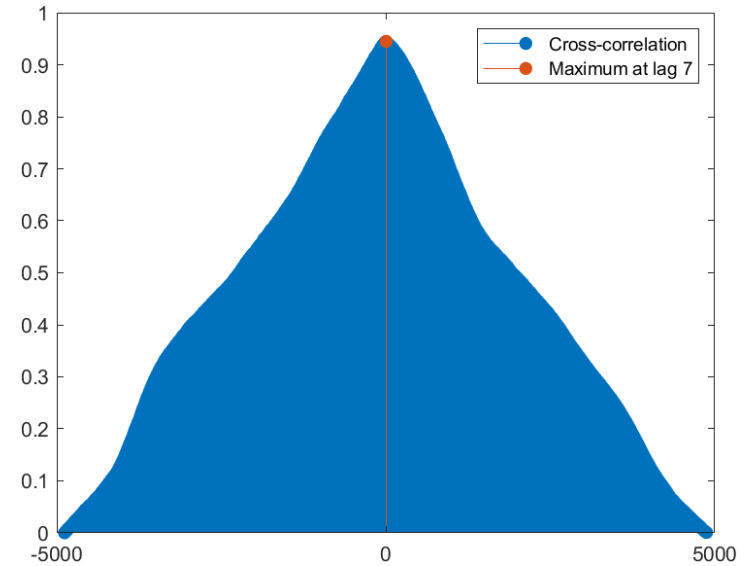
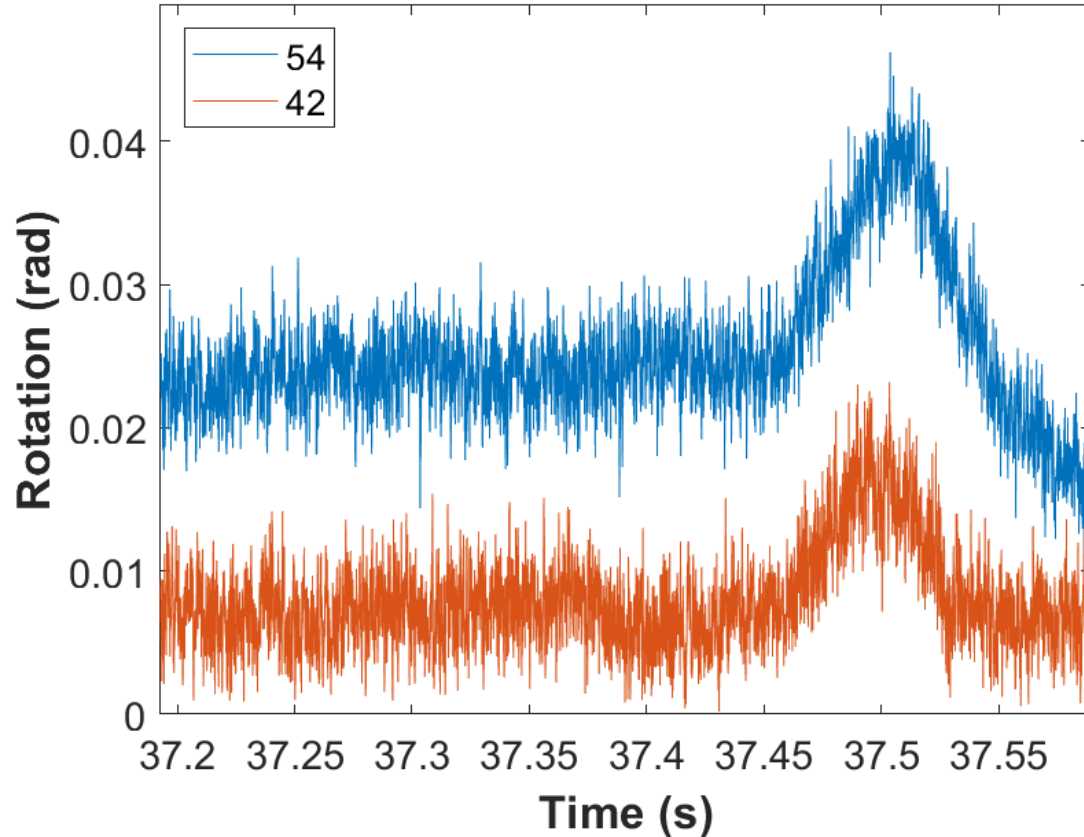

Lag of 7 samples

Sample freq:  $8.1920e-05$  [sec/sample]

$\Delta t$  will be 0.57344 [ms]

Can we verify if something happened at  $x=66.4$  km on Tuesday, April 13, 2024 17:09:41.529 PM (GMT) with DAS?

## Scattering based sensing



# Spontaneous and stimulated scattering in optical fibers

- Scattering in general caused by interaction of light with atomic structures and particles in the fiber in one way or another
- The scattering mechanism used for sensing
  - Rayleigh Backscattering (RBS),
  - Spontaneous Raman Scattering (SpRS)
  - Spontaneous Brillouin Scattering (SpBS) and Stimulated Brillouin Scattering (SBS)
- Each scattering process is always present in optical fibers
  - no fiber is free from microscopic defects or thermal fluctuations which originate the three processes.

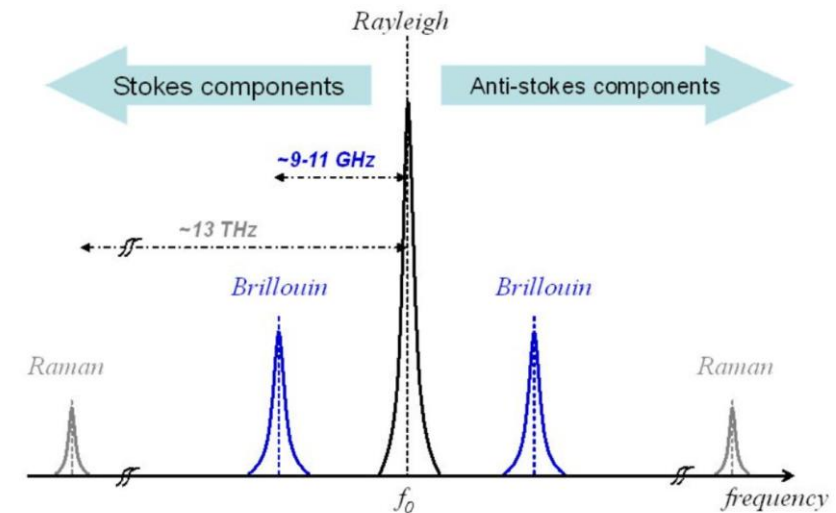
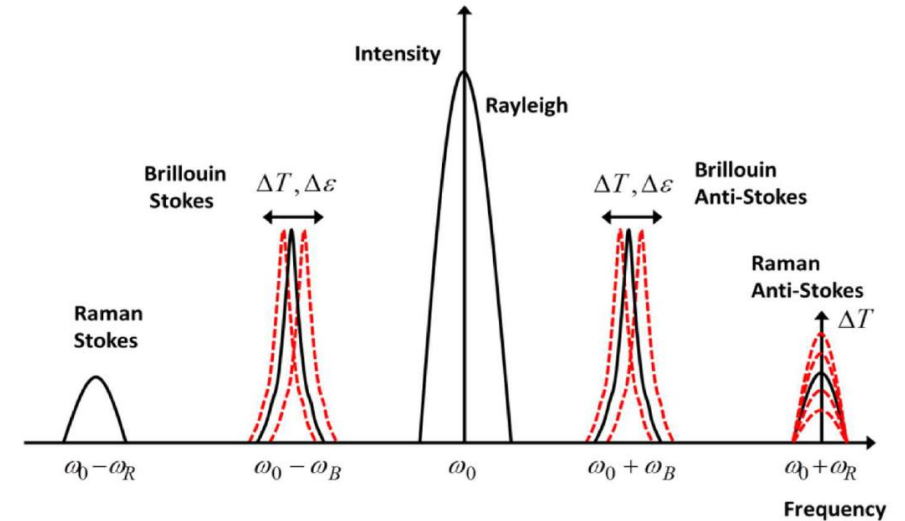



## Rayleigh backscattering based Sensing Distributed Acoustic Sensing (DAS)

- Elastic collisions between the light wave and the silica molecules result in **Rayleigh scattering**.
- Rayleigh scattering accounts for about **90%** of attenuation in optical fiber.
- Rayleigh backscattering can be used to measure the Strain. Since the strain is often caused by acoustic vibrations, the term DAS is normally used for these measurements.

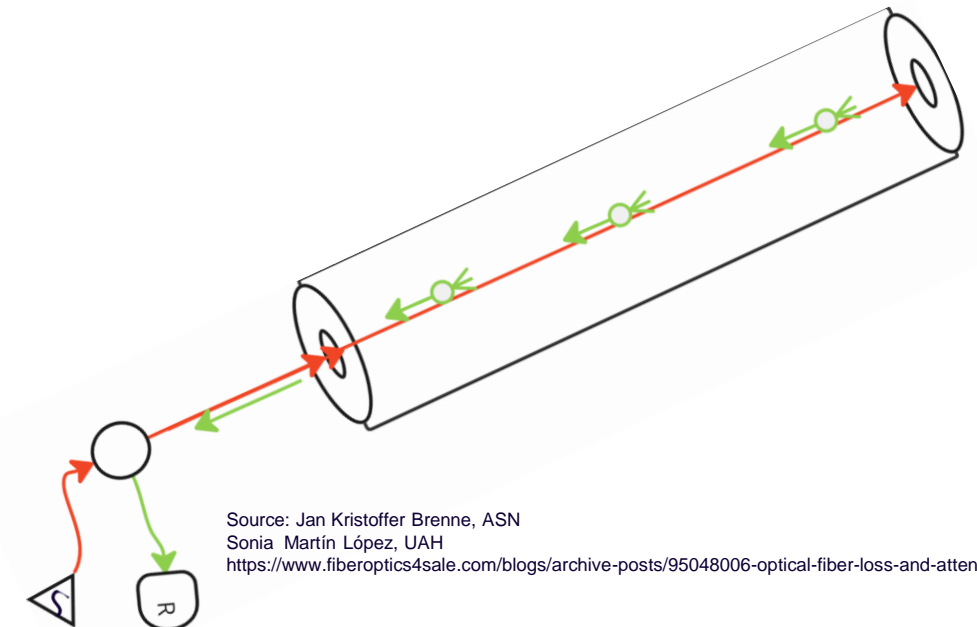
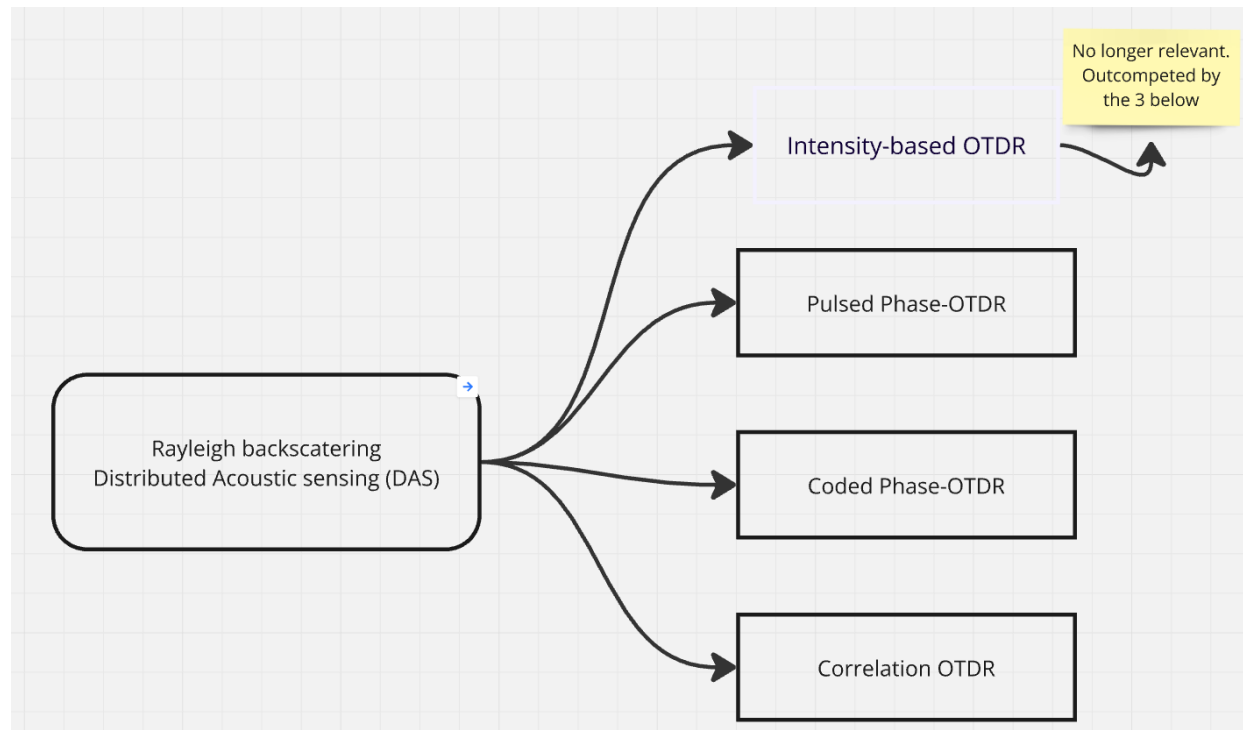

# DAS Interrogation Techniques

□ The common technique for measuring the reflected DAS signal from the fibre is ***pulsed interrogation***

- Short coherent pulses are launched into the fibre. Spatial resolution is limited by the pulse length (typical in the range of 1-10 m). Pulse repetition rate is limited by the fibre length. With short pulses a relatively low optical energy per interrogation period is then launched into the fibre (low duty cycle).

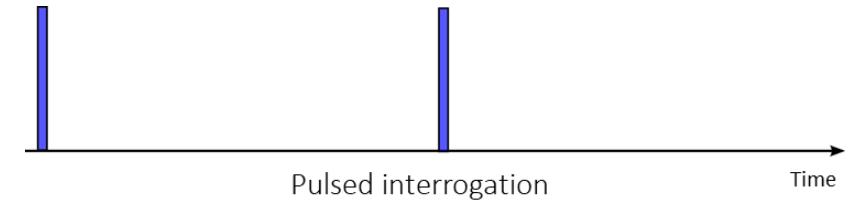

- ✓ *Spatial resolution limited by the pulse width*
- ✓ *Low duty cycle (shot noise limited)*
- ✓ *Typical range is 40 – 50 km*

□ The ASN technique for measuring the reflected DAS signal from the fibre is ***frequency swept interrogation***

- A linear frequency modulated optical signal is launched into the fibre during a much longer duration (than used with pulsed interrogation). Much more optical energy per interrogation period is then launched into the fibre (higher duty cycle). This significantly improves the power budget. The spatial resolution is determined by the optical sweep bandwidth.

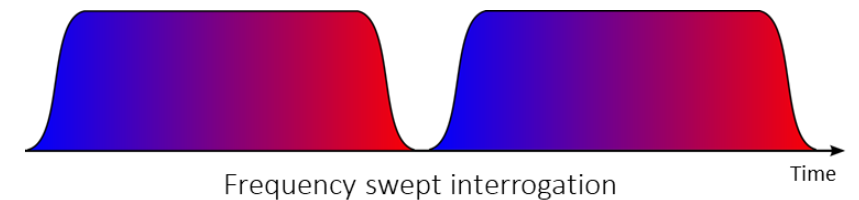

- ✓ *Spatial resolution limited by the inverse of the sweep bandwidth*
- ✓ *High duty cycle (not shot noise limited)*
- ✓ *Typical range is 140 – 150 km*

Costa, Fully distributed optical fiber strain sensor with 10–12  $\epsilon$ /Hz sensitivity, J. Lightwave Technol., № 37, c. 4487  
<https://doi.org/10.1109/JLT.2019.2904560>

Ole Henrik Waagaard, Erlend Rønnekleiv, Aksel Haukanes, Frantz Stabo-Eeg, Dag Thingbø, Stig Forbord, Svein Erik Aasen, and Jan Kristoffer Brenne, "Real-time low noise distributed acoustic sensing in 171 km low loss fiber," OSA Continuum 4, 688-701 (2021) <https://doi.org/10.1364/OSAC.408761>

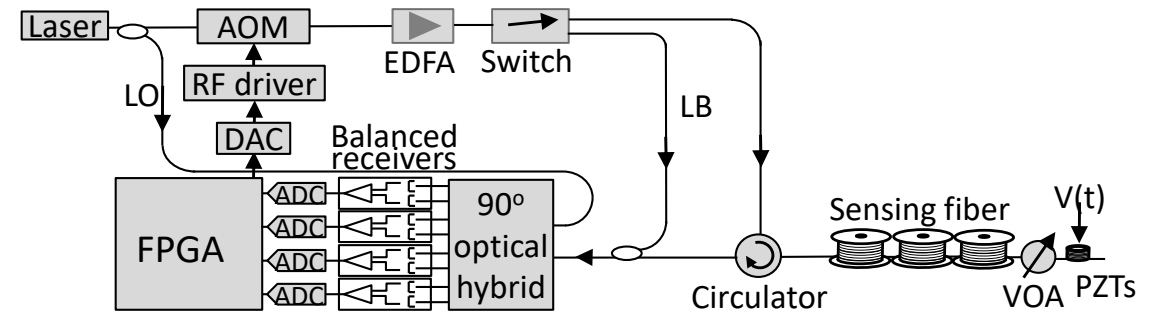
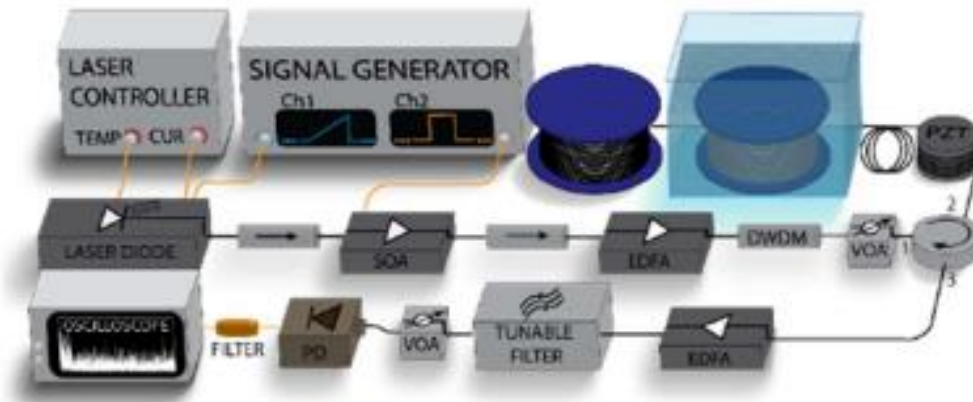
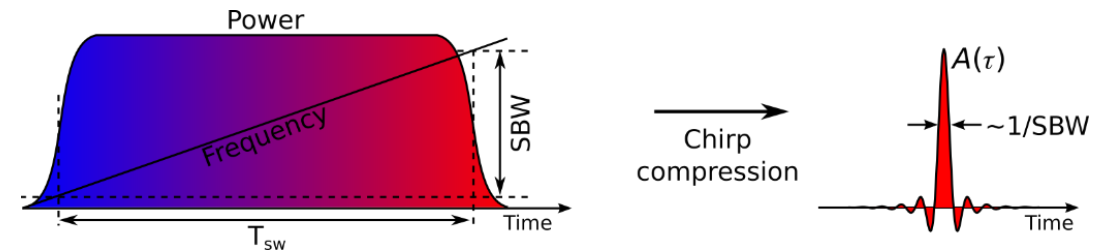
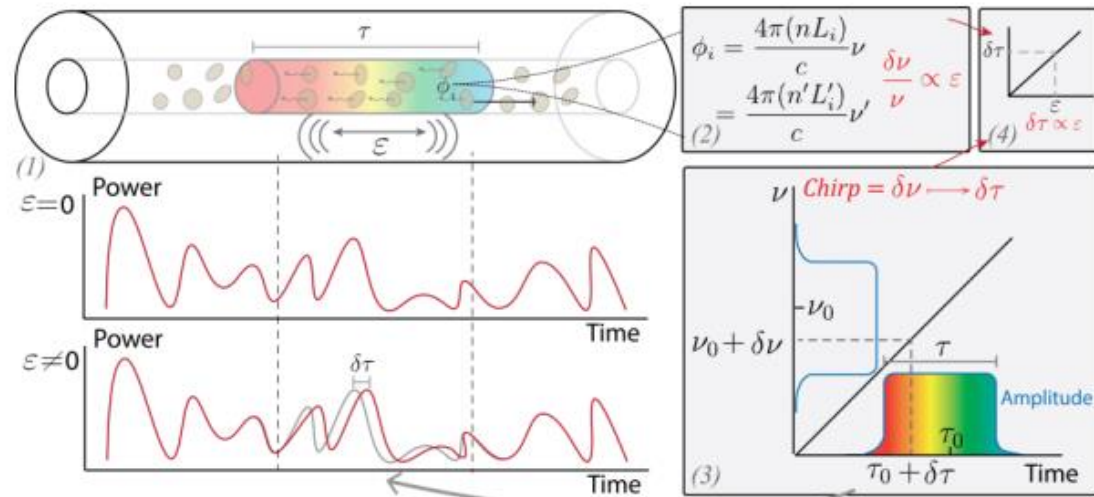

## Rayleigh backscattering (RBS)

To detect and locate the acoustic vibrations along the optical fiber and find the cause of it

## T waves

M6.0 earthquake in Algeria 18/03/2021

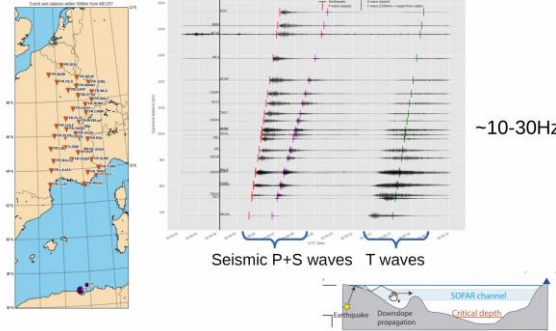

~20Hz

~10-30Hz

## Deep-sea currents

Vortex Induced Vibrations (VIV)

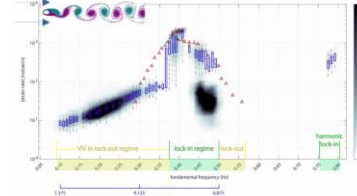

$$f_{VIV} = S_i \frac{U_c}{D}$$

Validation with a nearby ADCP

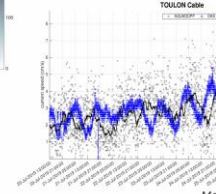

## Thermometry with LF-DAS

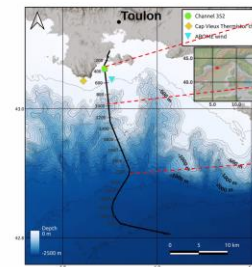

LSPM cable, Toulon - 2 weeks, 2019

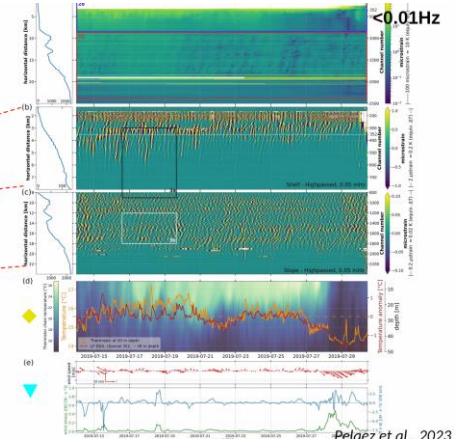

Pelaez et al., 2023

## Surface gravity waves

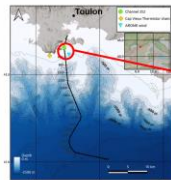

DAS sensor vs Pressure Sensor

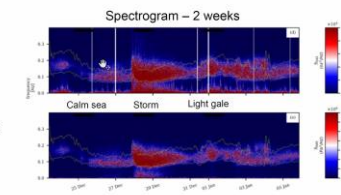

0.1Hz

## Can we detect tsunami waves?

3 candidates for DAS signal:

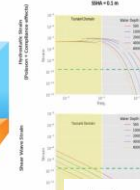
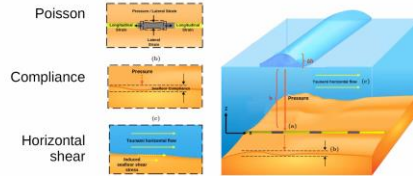

Becerril et al., submitted

## Biophony (at a lower volume)

Samuel Meulé, Julian David Pelaez Ouirfonas, Frédéric Bouchelle, et al. Reconstruction of nearshore surface gravity waves from Distributed Acoustic Sensing data. Earth and Space Science, accepted. DOI: 10.22464/essoc.170957096.89814320v1

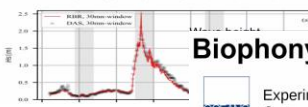

Experiment with Oceanographic Museum in Monaco

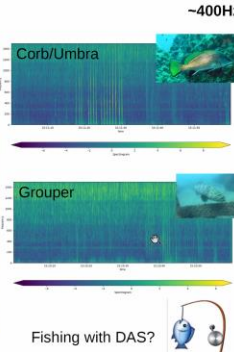

Fishing with DAS?



sediments, M-6.8 in 1887. Seismic region

A key area to study deep-water convection

## Tracking of fin whales



~20Hz

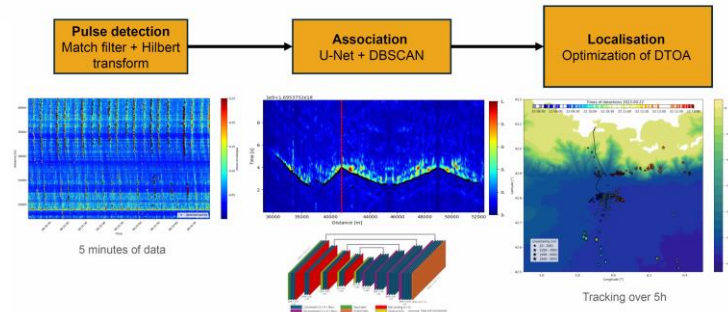

N Dumont: Master intern Avril-Août 2024

## Raman Scattering and sensing concept

Spontaneous Raman Scattering is resulting from the interaction of light with the **vibrational or rotational modes of molecules** in the fiber core.

A **molecular vibration** is a periodic motion of the atoms of a molecule relative to each other, such that the center of mass of the molecule remains unchanged.

The **intensity of anti-stokes scattered component** is strongly depends on the temperature around the fiber



This make it possible to measure **distributed temperature in the time domain**.

Known as Raman Distributed Temperature Sensing (**RDTS**)

# The concept of Raman Distributed Temperature Sensing (RDTS)

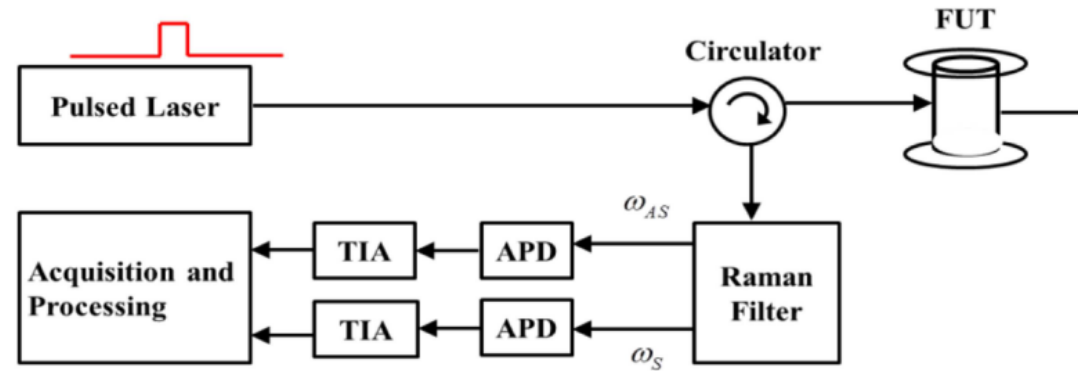

- RDTS allows distributed temperature measurements without any cross-sensitivity with other parameters such as strain



## (Spontaneous and stimulated) Brillouin Scattering

Brillouin scattering occurs due to the interaction of light with the sound waves or the acoustic phonons of a material.

**Acoustic phonons** are coherent movements of atoms of the lattice out of their equilibrium positions. If the displacement is in the direction of propagation, then in some areas the atoms will be closer, in others farther apart, as in a sound wave in air (hence the name acoustic). [Phonon article @ Wikipedia]

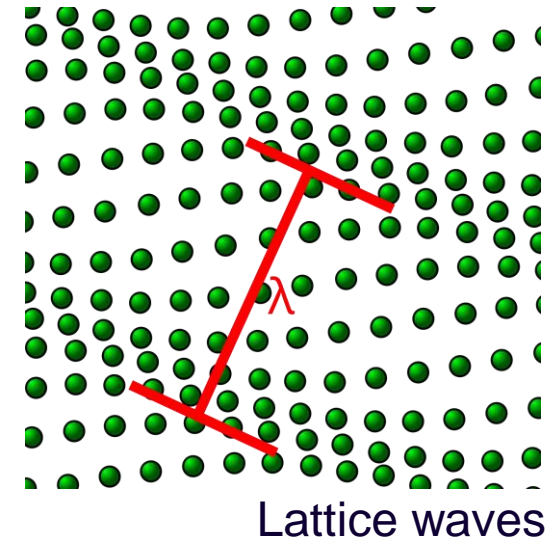

*Stimulated Brillouin Scattering happens when the intensity of the light is high enough to change the intensity of the material in fiber core*

# The concept of Brillouin Optical Time Domain Reflectometry (BOTDR)

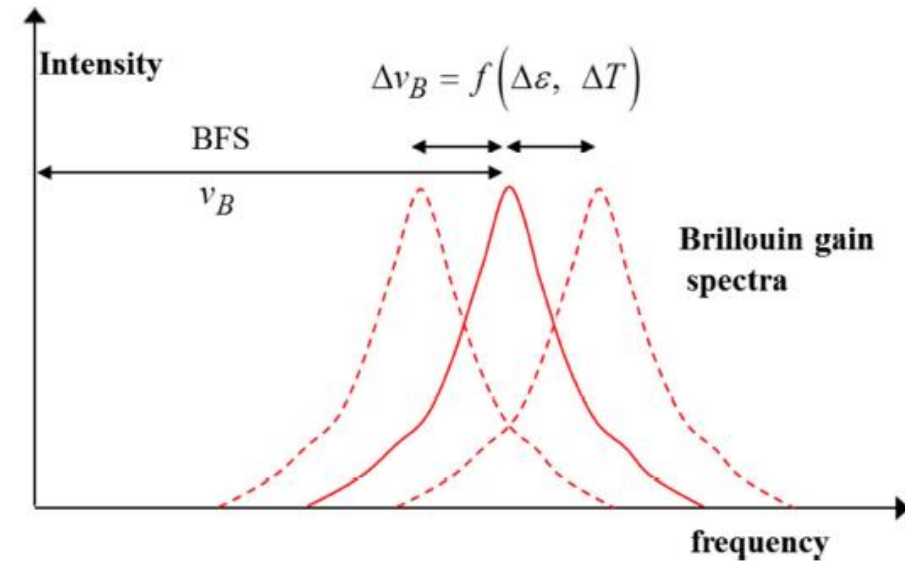
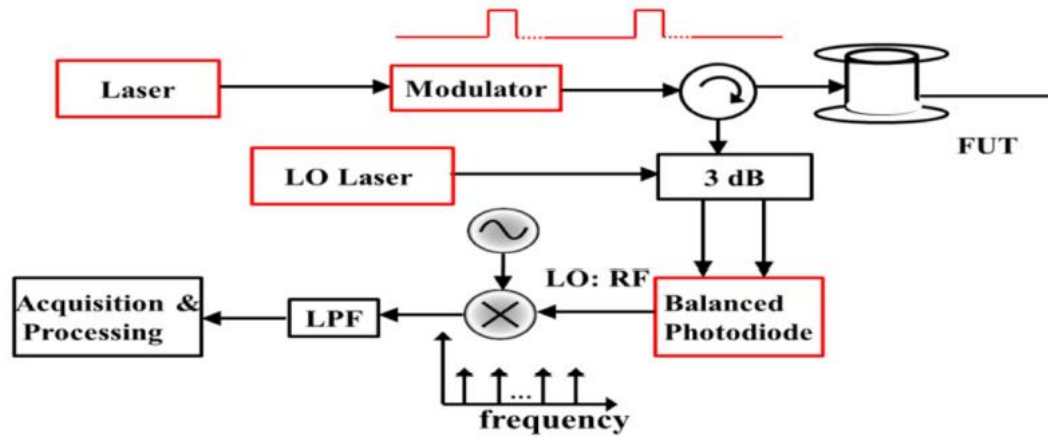

- Brillouin Frequency Shift (BFS), is linearly dependent on the strain or temperature at each point of the fiber
- Sensing is based on measuring the frequency offset between the peak of the Brillouin Gain Spectrum (BGS).
- Distributed measurement with this technique boils down to determining the distributed BFS along the fiber.
- Brillouin-based sensors suffer from cross-sensitivity of temperature and strain which require other techniques to resolve.

## The concept of Brillouin Optical Time Domain Analysis (BOTDA)

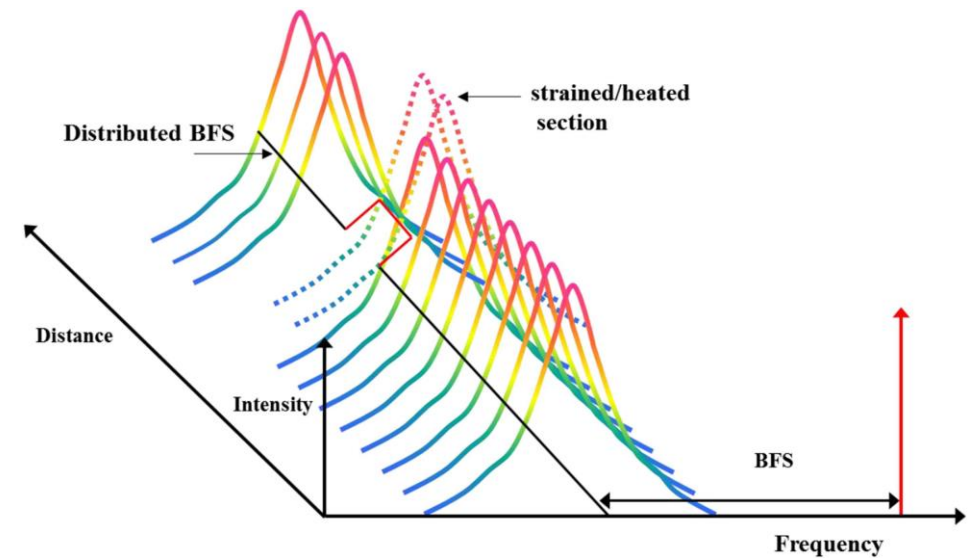
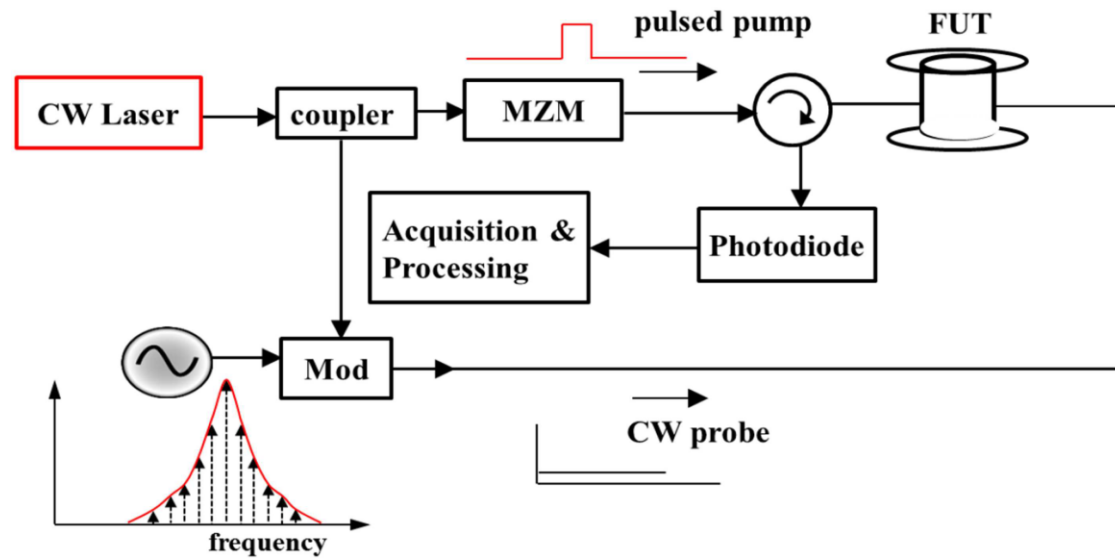

- Based on spontaneous Brillouin scattering
- Needs both ends of fibers (the Signal and Probe ends)
- As BOTDR, sensing is based on measuring the frequency offset between the peak of the Brillouin Gain Spectrum (BGS).

## OFC24 papers on BOTDA and BOTDR

- BOTDR systems based on spontaneous Brillouin scattering can sense temperature and strain changes in fiber at a length of 100 km
  - Commercially available (LIOS EN.SURE from LUNA)
- Using distributed Raman amplification and remotely pumped Erbium doped fiber (EDF) amplification, the sensing range of repeater-less BOTDR sensing can be increased to 250 km [1]
- BOTDA as a monitoring tool to identify fiber types present in deployed hybrid-span fiber cables [2]

# Submerge test activities in Svalbard

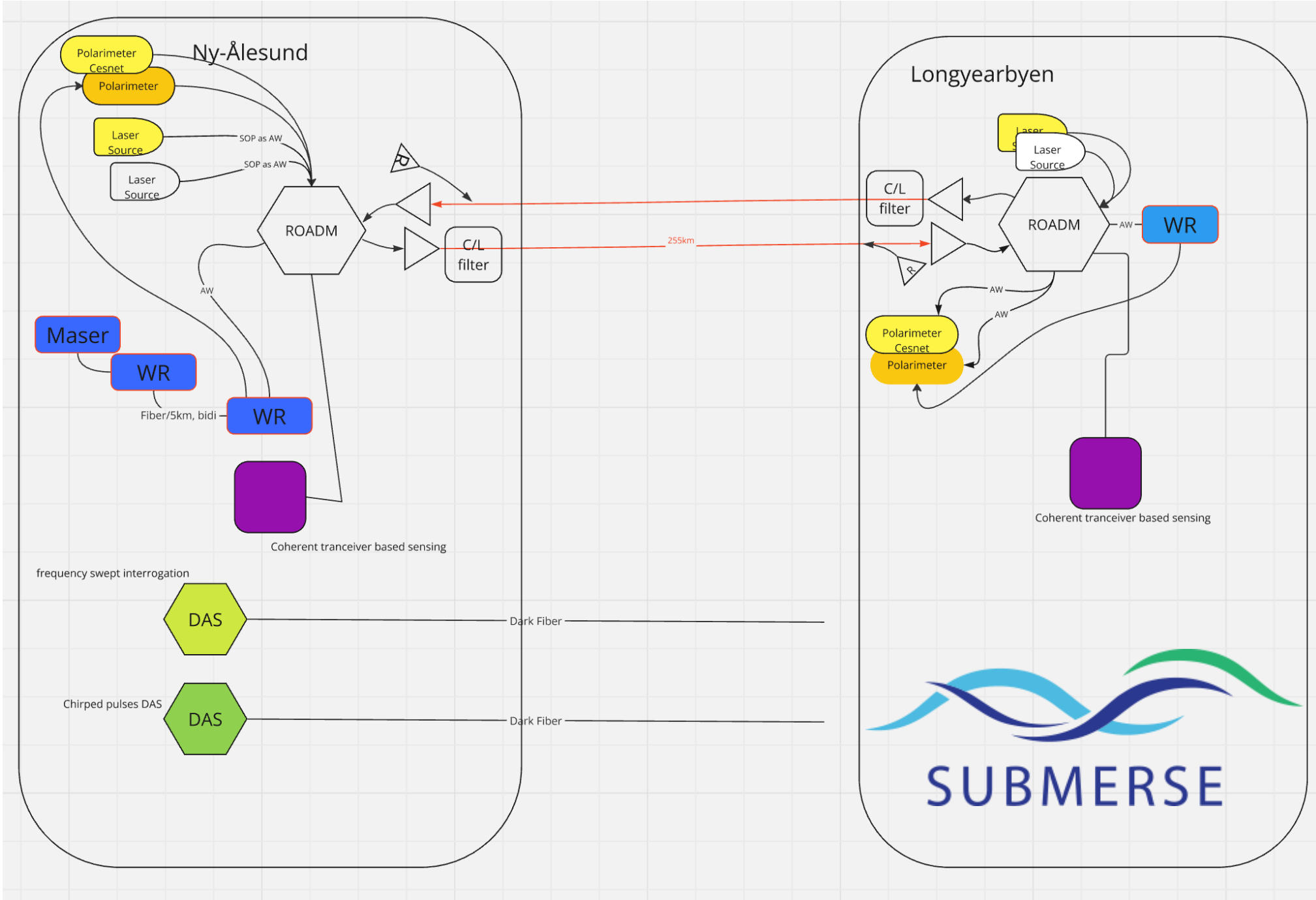



Thank you!

[kurosh@sikt.no](mailto:kurosh@sikt.no)